

HIGH POWER CHARACTERIZATION

Automated Measurement System

KEY FEATURES

- Automated High Power switching - 100 A and 3 kV
- Complete automatic process
- Enable high accuracy characterization
- Predefined & safe setup
- Flexibility with user-defined test plans
- Worldwide service calibration support for individually SMU's
- On wafer and packaged in only one system
- Easy to extend with MeasMatic for future requirements
- Wafer Prober and other devices are pluggable e. g. thermostream

This Measurement Systems provides an all-in-one solution to characterize 2- and 3-pole power devices as field effect (FETs), bipolar junction (BJTs) transistors, diodes and capacitors up to 3kV and 100A.

With a single DUT insertion all relevant parameters of off-state and on-state as well as the characteristic capacitances (Ciss, Coss Crss) can be measured. The IV characterization can be done in pulsed, but also in DC mode.

This allows a plus in efficiency and prevents any rewiring mistakes.

For testing on-wafer components, the instrument switching solution can be placed close to the DUT and integrates seamless, with a MPI High Power Wafer Probe System.

With the integrated test sequencer, it also greatly fits into automated environments and can be used to characterize entire wafers or for incoming inspection pass-fail tests. Optionally, the setup can be combined with the Ultrafast Dynamic RDS(on) measurement solution.



IVCV TEST SYSTEM

Static system for characterization of vertical and lateral devices

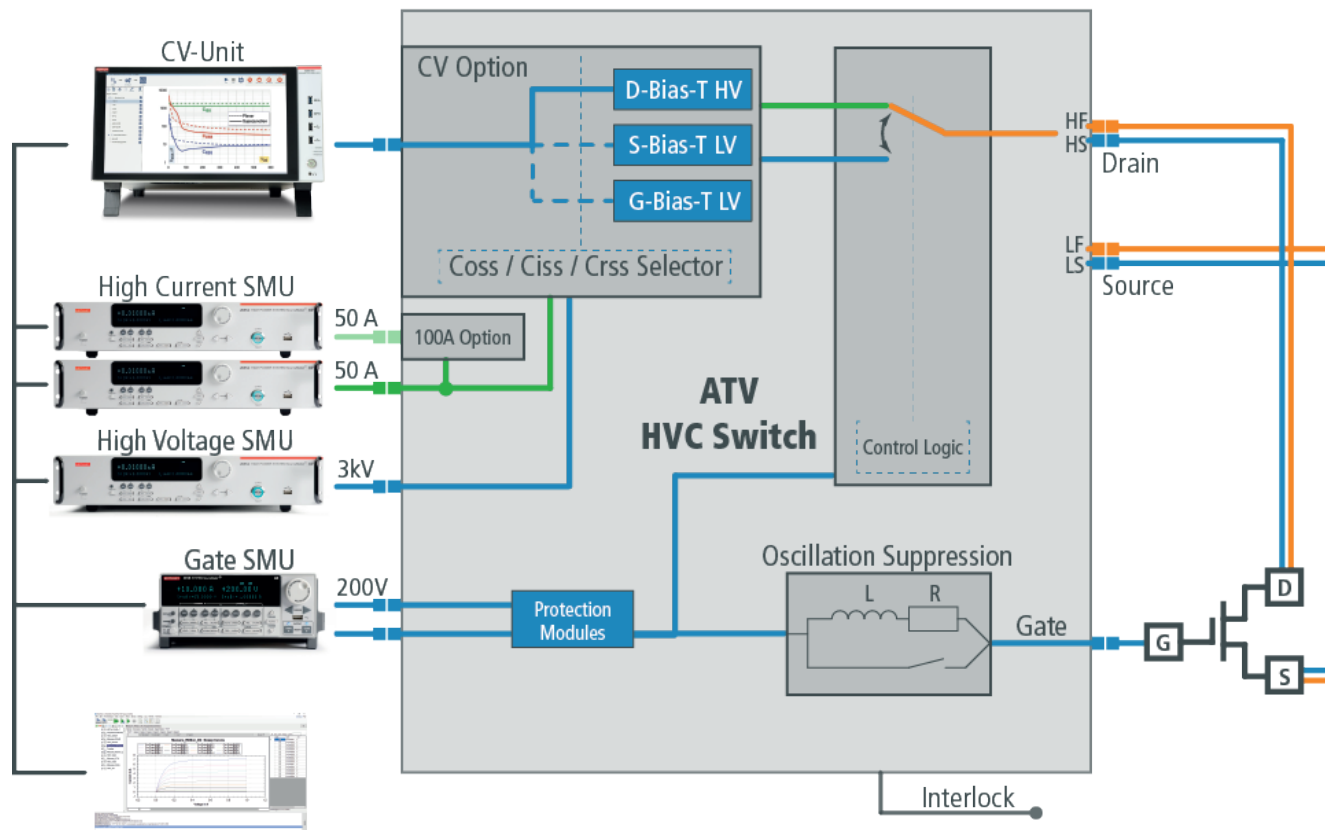

HVC-Switch setup

COMPONENTS

- Keithley 2657A - High voltage SMU
- Keithley 2651A - High current SMU
- Keithley 2612B - up to 200 V
- Keithley PCT-CVU
- Rack 38HE incl. heavy duty castors (optional ESD)
- PC incl. Display and Keyboard
- ATV MeasMatic Software
- Feedthrough adaptation for MPI Wafer level test or package level test (Adaption card for probe card holder)
- HVC Switch

AVAILABLE OPTIONS

- Option 1: 100 A (requires additional Keithley 2651A)
- Option 2: CV
- DUT board fixture for packaged devices

MEASUREMENT CAPABILITIES

OVERVIEW

- Output characteristics
- Transfer characteristics
- Drain leakage (IDS Off)
- RDS(on)
- Gate leakage / Sub threshold
- Fast Vth
- Pulse shape analysis
- Vth in accordance with Jedec JESD 28A/60A
- Body diode
- CV-Characterization: Ciss/Coss/Crss

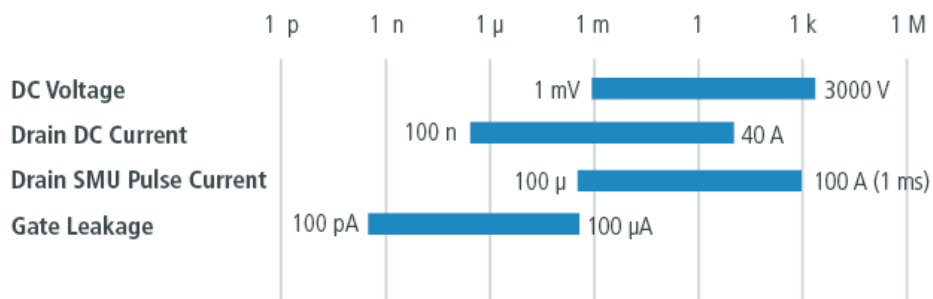

Output characteristics

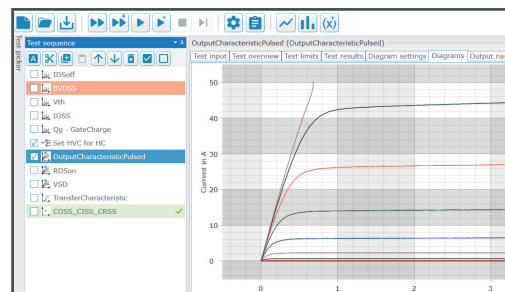

Transfer characteristics

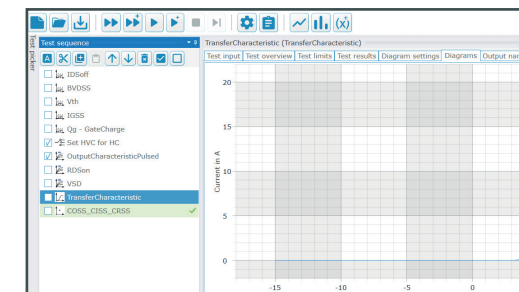

IDSoff

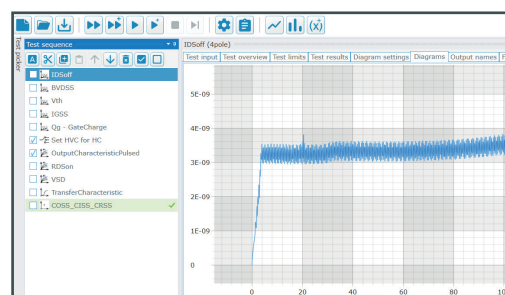

Gate charge

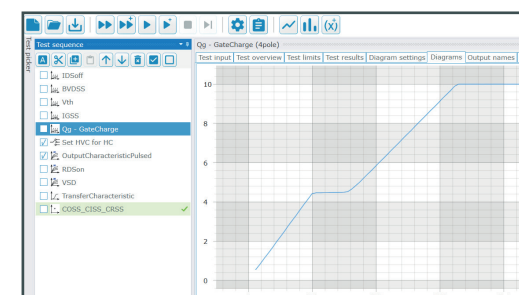

Ciss/Coss/Crss

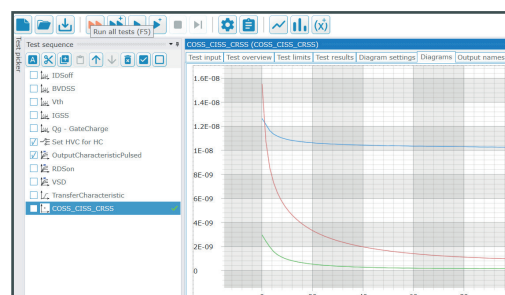

Gate leakage

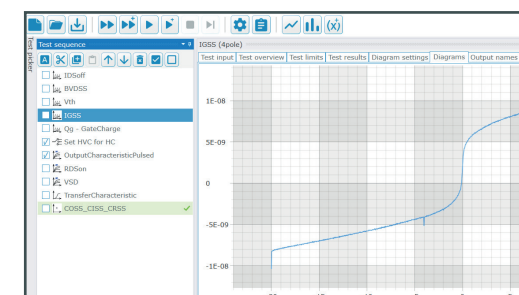

ATV MEASUREMENT SOFTWARE

Measmatic

SOFTWARE

- Based on ATV Measmatic Framework
- Free configurable test sequences
- expandable custom tests are simple programmable
- Userdefined export formats
- Report documents
- Application and customization support

Measmatic

ATV Measmatic is the software components, that provides an easy-to-use interface. With its flexibility it is ideal for research applications and allows the engineer to create test recipes, define parameters, analyze and compare data graphically.

Measmatic provides an open structure for expanding and modifying the functionality as the test demands are changing.

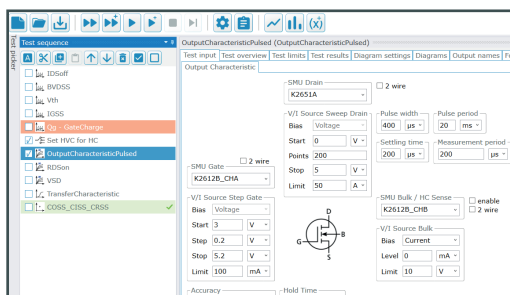

Output-Setup „Test configuration“

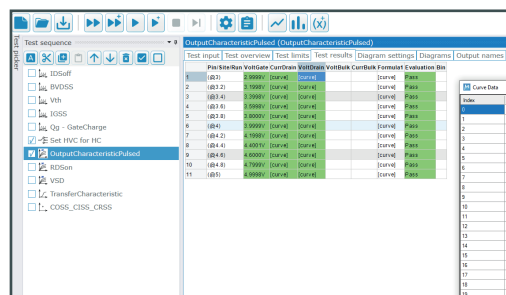

Data

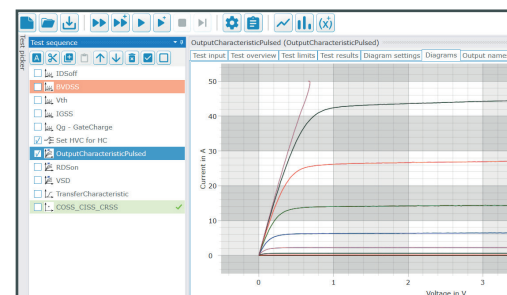

Graphical Output

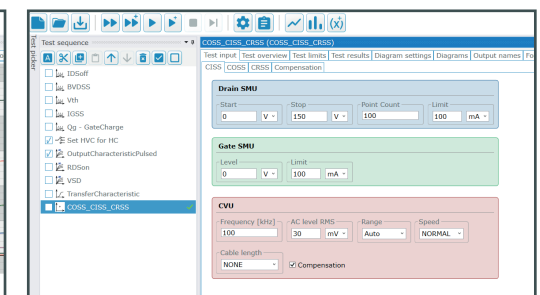

CV-Test Setup